

# zortrax

## 3D Printer User Guide

### M Series Plus



## Table of content

Introduction	3
Intended Use of Zortrax Printers	3
General Safety Information	4
Warning and Safety Labels on Zortrax Devices	6
Learn More About the Zortrax M Series Plus	8
How does the Zortrax 3D printer work?	8
What's in the Box	9
Main Components	10
Zortrax 3D Printing Technology Glossary	12
First Use Preparations	17
Connecting the printer to a network	26
Firmware Update	30
Navigating through the Menu	32
Material Loading	34
Platform Calibration	37
Z-SUITE Installation	39
Starting and Removing a Print	39
Available Materials	44
Basic Maintenance and Service Work	44
Support and Troubleshooting	51
Specification	55
Recycling	58

## Introduction

Read this User Guide carefully and thoroughly before operating Zortrax products for the first time. The User Guide includes basic information about the 3D printer, safety and protection guidelines as well as advice on preparing the machine for the first printing and basic maintenance work. Ignorance and non-compliance with these instructions may result in property damage, injuries, device failures or lower quality of 3D prints. It is also necessary to ensure that every 3D printer user knows, fully understands and follows the instructions provided in this User Guide.

The Manufacturer makes every effort to ensure that Zortrax products are safe in transportation, installation, usage, storage and disposal. However, due to the lack of direct and ad hoc control as well as other conditions influencing the device and those that are beyond the Manufacturer's knowledge, the Manufacturer is not responsible for damage, injuries, failures and costs resulting from improper transportation, installation, usage, storage and disposal.

Furthermore, the users should take into consideration the risk of possible damage of the device resulting from defects in material and workmanship.

## Intended Use of Zortrax Printers

Zortrax 3D printers work in the Layer Plastic Deposition (LPD) technology, in which a previously melted material is deposited on a surface layer after layer in order to form a pre-designed shape. The extruder is equipped with three heating points, which allows the melted material to exit the nozzle and be deposited onto the heated platform without causing blockages.

The users are responsible for qualifying and determining the intended use of 3D printed models. The Manufacturer takes no responsibility for any use of the printed objects, especially when those objects constitute a part of safety equipment or strictly regulated medical, military or space science equipment.

Due to the size and specificity, Zortrax devices are not intended for use by children under the age of 14 and by people with reduced manual, motor and psychomotor skills. The Manufacturer recommends providing assistance and guidance to people with disabilities and older adults who wish to operate the printers.

## General Safety Information

This User Guide contains important safety directions that should be followed during installation and operation of Zortrax 3D printers. It also mentions situations which require special attention and includes warnings against negligence and misuse that could cause damage or injuries.

Always read the safety data sheets available at: <https://zortrax.com/filaments/>. They are a source of basic information and safety procedures for the materials you use. It is essential to **update the firmware** to avoid any kind of failures. Visit our website: <https://zortrax.com> regularly to learn about the latest news and updates.

Zortrax 3D printers operate at high temperatures and have easily accessible movable components, therefore, you must be particularly careful when handling or operating the devices. It is extremely important to avoid situations that may lead to burns or interference in the device's proper functioning.

Do not leave the machine **unattended** during the print job - check it periodically for proper functioning in order to avoid potential accidents or breakdowns. Turn off the printer once the print job is finished. Monitor your device for wear and tear regularly. Contact our **Support Center** at: <https://support.zortrax.com/> for assistance while replacing worn or broken parts.

Keep the printer away from heat sources, fire, flammable materials, humidity as well as water and other liquids. Place the machine away from any equipment emitting radiation. To prevent any inadvertent use, keep the device out of reach of children and animals. It is forbidden to shake or drop the printer as it may cause breakdowns. The equipment is not intended for use in a potentially explosive environment.

## Health and Safety at Work

All service and maintenance activities as well as device operation require wearing safety gloves included in the Starter Kit. Wearing safety gloves is also advised while removing finished print from the platform.

The Manufacturer strongly recommends setting up a special room dedicated only to 3D printing. The room should be properly ventilated. At the same time, the Manufacturer does not recommend staying in a room where devices have been 3D printing for a long time. The vapors released during the printing process do not pose a direct hazard, but they can have negative effects when combined with accumulated dust particles in long-term processes.

Food and beverages should be kept away from both the 3D Printer and the 3D printed objects. While operating Zortrax devices, all measures regarding health and safety provided in this User Guide as well as in separate regulations should be taken into account.

## Electrical Safety

Zortrax 3D printers have been tested for compliance with Low Voltage Directive. In order to ensure the highest safety standards, including protection against short circuit, overload, overvoltage and printer overheating, do not attempt to modify the printer and do not use electronic replacement parts other than those recommended by the Manufacturer.

Replace electronic units according to the instructions and be particularly careful while using the tools supplied with the printer.

Before plugging the power cable into the outlet, make sure that the power supply voltage in the outlet matches the required value provided on the nameplate at the back of the printer. Avoid overloading the outlet with too many devices.

The printer must be well-grounded. Always make sure that the ground complies with local and national regulations.

Use only the original power cable supplied with the printer. Do not damage, cut or repair the cable. A damaged cable should be immediately replaced with a new one.

All maintenance and repair work should be carried out while the device is off and unplugged. Do not expose the device to moisture and liquids. Modifications such as soldering of electronic subunits are forbidden.

## Mechanical Safety

Zortrax 3D printers have movable components, such as the drive belts, extruder or platform. Therefore, it is forbidden to reach into the printer or put anything inside the printer when it is running, about to start running or at rest. This may lead to serious injuries or damage.

Tools and accessories from the Starter Kit box should be used with special care only for intended purposes. Improper use of the tools may cause serious injuries.

While following post-processing procedures, wear safety gloves and glasses in order to avoid injuries that may be caused by sharp edges and fragile elements of the models.

To avoid injuries, be particularly careful while removing the prints from the platform. Always wear safety gloves and glasses.

## Risk of Burns







There is a high risk of burns while operating Zortrax printers as the extruder's temperature may reach up to 290° C [554° F]. Do not touch the extruder with bare hands. Be extremely careful during maintenance and repair work of heated units. If it is necessary to touch a heated component, use the pliers which are specially adapted for this purpose. Cooling of components should not take less than 30 minutes.



The platform's temperature can reach up to 105° C [221° F], therefore, special care should be taken while operating the printer or while removing the finished print.

Do not ignore the warning labels placed on the device.

Moreover, constructional modifications of the printer's operating temperature are not permitted as it may cause serious injuries or bring damage to the device.

## Warning and Safety Labels on Zortrax Devices

	Hot surface. Allow to cool before touching
	Due to design characteristics, the screws that secure the Z-axis screw nut cannot be fully tightened
	Do not attempt to modify or remanufacture the product
	Remove the print from the platform with extreme care
	Wear safety gloves
	This symbol indicates that special care should be taken when repairing the device. Also, it points out an important step to be carried out

	The printer needs to be placed on a flat and stable surface to ensure proper quality of the prints
	Hot surface. Do not touch
	Do not reach into moving elements

## Safe Storage and Transport Guidance

Zortrax devices must be stored between 0 and 35° C [32 - 95° F]. The storage space should be free of moisture and other extreme conditions.

## Transport Instructions

When stacking several devices on a pallet, follow the instructions provided on the packaging. One device may weigh more than 20 or 50 kg [44 or 110 lb]. It is therefore advisable to provide safe pallet storage but not higher than 1.7 m [5'7"]. It should be noted that the packages must not project beyond the outline of the pallet. Packages stacked on the pallet should be then bound together and wrapped in foil. The pallet prepared as above can be then forwarded to the shipping company.

Pallet stacking and destacking should be carried out by two people. The package with the device should be lifted or moved using special handles.

## Electromagnetic Compatibility (EMC)

Each Zortrax printer complies with Part 15 of the FCC rules. Operation is subject to the following two conditions: (1) this device may not cause harmful interference, and (2) this device must accept any interference received, including interference that may cause undesired operation.

This equipment generates, uses, and can radiate radio frequency energy and, if not installed and used in accordance with this instruction manual, may cause harmful interference to radio communications. Operation of this equipment in a residential area is likely to cause harmful interference, in which case the user will be required to correct the interference at his own expense.

## Learn More About the Zortrax M Series Plus

The Zortrax M Series Plus includes two 3D printer models - the M200 Plus and M300 Plus, which together with Z-SUITE and dedicated materials constitute the whole 3D printing ecosystem. Thanks to these devices, it is possible to turn digital, three-dimensional projects into reality using the Layer Plastic Deposition (LPD) technology. The LPD technology involves applying one layer of material after another in order to form a pre-designed shape. Zortrax 3D printers can be used in many industries while designing and prototyping, for instance, automotive parts, mechanical elements, conceptual models, everyday objects as well as decorative elements.

### How does the Zortrax 3D printer work?

Everything begins with preparing a model. The work on the model can be started in any program which creates 3D models and generates .stl, .obj, .3mf or .dxf files. These are the standard file formats supported by most 3D modeling software - the model is saved as a set of three-dimensional triangles (triangle mesh).

The next step is to open the .stl file (or other) in Z-SUITE - the program created specifically for Zortrax devices. Z-SUITE prepares the model by slicing it into individual layers and saving it as a .zcodex file. Each layer represents the movement pattern of the extruder and the platform while building the whole object. Z-SUITE also allows you to choose the material type to be used for the model and to adjust the necessary print settings, such as the size of the model, layer thickness, the type of infill or how many support structures should be generated. The file is then ready to be printed.

To start the printing process, turn on the printer, prepare and load the material which corresponds with the one you have chosen in Z-SUITE. The full material offer is available at: <https://zortrax.com/filaments/>. While working with M Series Plus printers, you can start, stop and pause the printing process in Z-SUITE. Once your file is prepared, you can transfer it from Z-SUITE to the printer's storage in two ways. You can either save the file on a USB flash drive and plug it into the port at the front of the printer or transfer the file from Z-SUITE over Wi-Fi/Ethernet cable. In addition, Z-SUITE allows you to add several printers to the program's panel and create a network of devices. This solution makes it possible to produce 3D models in a small series and manage the whole process from the screen of your computer. Each printer can still be operated using the touchscreen at the front.



## What's in the Box

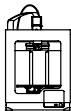

Zortrax M Series Plus  
3D Printer



Material Spool  
Holder



Side Covers



Material Spool



Platform



Power Cable



USB Flash Drive



Z-SUITE &  
Quick Start Guides



Safety Gloves &  
Safety Glasses



Cutting Knife &  
Scalpel



Allen Keys



Nozzle Key &  
Nozzle Needle

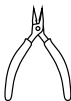

Pliers



Spatula &  
Tweezers



Service Grease



Material Guide

## Main Components

### 1. Front view

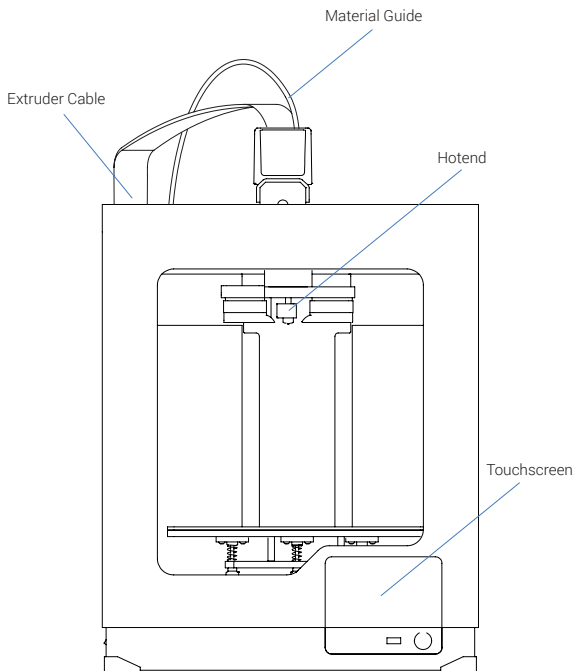

## 2. Right-side view

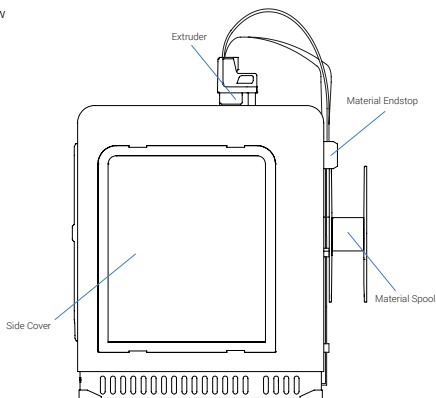

## 3. Left-side view

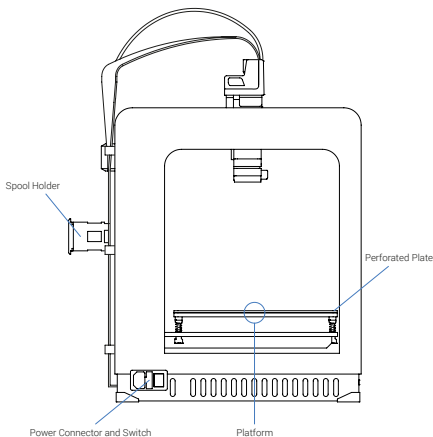

## Zortrax 3D Printing Technology Glossary

### **EXTRUDER**

the mechanism which ensures material feeding, heating and extruding as well as cooling of the print. Its main components include the hotend and the nozzle. The material is melted in the hotend, and then pushed through it until it exits the nozzle. The melted thermoplastic is deposited layer by layer to form a predesigned shape. Additionally, there are three fans on the extruder: one which cools the whole mechanism and two which cool the print.

### **EXTRUDER CABLE**

the ribbon cable which connects the extruder with the motherboard. It supplies the extruder with electricity and allows the motherboard to regulate the printing process.

### **FIRMWARE**

the software programmed into Zortrax printers, which controls and monitor all the data in the device. It also gives the possibility to enable/disable the printer's functions.

### **HOTEND**

an essential heating system which consists of an aluminum block and a heater & thermocouple. The hotend is responsible for heating and melting the material as well as for ensuring the proper temperature of the material during the whole printing process. In addition, the hotend is less likely to become dirty thanks to the teflon cover.

### **LPD (LAYER PLASTIC DEPOSITION) / FFF**

a technology used by Zortrax M Series Plus printers, in which a melted material is deposited on a surface. This technique involves applying one layer of material after another in order to accurately form a computer-designed shape. The printer starts to print from the bottom and builds the object until it is fully formed. The model and the support structures are created using the same material.

### **MATERIAL ENDSTOP**

the device placed at the back of the printer, which detects the presence of material and reacts when it runs out. If during the printing process a spool of material is finished, the material endstop will automatically make the printer pause the printing and allow the user to load new material.

## MATERIAL GUIDE

the tube which feeds the material from the spool to the extruder at the proper angle. The material guide in the M Series Plus printers has to be attached to the extruder and to the material endstop placed at the back of the printer.

## MATERIALS

specially dedicated Zortrax printing materials which maximize the benefits of 3D printing. These thermoplastic materials are in the form of filaments wound on a spool. Zortrax offers a wide choice of materials, which are available at: <https://zortrax.com/filaments/>. Each material has different properties and can easily be adapted to a wide range of needs and applications. Moreover, most of the materials can be mechanically or chemically post-processed.

## MODEL LIBRARY

the collection of ready-made models available within Z-SUITE. All models are divided into categories, for instance art & design, education or robotics. You can find many useful and attractive models there that have been uploaded by users of Zortrax printers. Moreover, there is also one category called Zortrax Parts, in which you can find models of parts that are useful when printing with Zortrax printers, for example extruder top covers.

## MOTHERBOARD

the most important part of every Zortrax printer, to which all the necessary components are connected. It is the main printed circuit board which makes it possible for other parts of the printer to communicate with each other. The motherboard is placed under the bottom plate, along with the cooling fan and the power supply unit.

## NOZZLE

the final element of the extruder. It is used to direct a flow of material throughout the entire printing process, allowing to form the desired shape of a model. In addition, the nozzle is less likely to become dirty thanks to the teflon cover.

## PLATFORM

an integral part of the 3D printer, on which the model is created. It consists of two parts: the heatbed and the perforated plate. Both parts are connected together with the use of screws and Pogo pins. The heatbed provides proper platform heating, whereas the

perforated plate increases adhesion of the model to the platform surface. The platform can easily be removed or put back in place.

## **PLATFORM CALIBRATION**

a procedure which lowers the risk of issues that may occur during the printing process. It involves checking the distance between the nozzle and five points on the platform, and tightening/loosening the calibration screws.

## **POST-PROCESSING**

all procedures of mechanical and chemical treatments that improve the final look of the model. Post-processing techniques include: polishing, sanding, smoothing, painting, or gluing two or more parts together.

## **POWER OUTLET AND MAIN SWITCH**

the switch enables turning the printer on and off. Next to the switch, there is a power outlet where you plug the power cable in.

## **RAFT**

the first few layers of material, which begin the whole printing process. These layers are always printed before the main object and have a larger area than that object. Once the printing is done, the raft needs to be removed from the platform together with the rest of the model. The raft enhances the adhesion of the whole print to the platform and reduces the risk of warping.

## **SIDE COVERS**

plastic panels that can easily be attached to the housing of the printer. They have been designed to provide protection from drafts and temperature differences that can occur in the printing room. Constant temperature inside the printing chamber is important for avoiding cracks and warping. The side covers protect the model during the printing process and help it to adhere better to the platform. The set of covers consists of: two side covers, one front cover, magnets, and hinges. The front panel is fixed to the housing with two hinges and closed by hidden magnets, whereas the side panels snap on. We especially recommend using the side covers for large-sized prints and prints made of materials with high or medium shrinkage level, like Z-ABS.

## SPOOL HOLDER

the element which is used to secure the spool of material at the back of the printer. The holder consists of two connected parts. It can be opened and closed with the push-to-open/close mechanism.

## STARTER KIT

several pieces of equipment that are put together in one set. Apart from the heatbed and the perforated plate, the set contains tools and protective equipment. The Starter Kit is needed to perform maintenance and repair work of your Zortrax printers. Each printer is delivered with equipment including, for example, a set of nozzle keys or safety gloves.

## STEPPER MOTOR

a type of electric motor in which the power supply does not cause full rotation of the motor shaft, but instead, a series of steps. There are four stepper motors in each Zortrax printer: two that are responsible for the extruder's motion, one which allows the platform's vertical motion, and one which enables material loading.

## TOUCHSCREEN

the display screen placed at the front of the printer, which enables fast and intuitive navigation through the device's menu. The screen also displays information about the current printing process and other information concerning the printer.

## Z-AXIS SCREW

the screw which is responsible for the platform's vertical motion. It is driven by a stepper motor placed under the the bottom plate. The Z-axis screw constitutes an integral part of the platform moving system.

## ZCODEX

a file format which contains a model prepared for 3D printing with previously selected print settings, such as layer thickness, infill type, etc. All print settings can be managed in Z-SUITE before generating the .zcodex. The .zcodex format can be transferred to the printer directly from Z-SUITE over Wi-Fi/Ethernet cable or using a USB flash drive.

## Z-SUITE

the application created specifically for Zortrax devices. Z-SUITE prepares a model for 3D printing by generating the file in the .zcodex format. Z-SUITE allows the users to change and adjust the print settings, such as the size of the model, layer thickness, the type of infill, or how many support structures will be generated. The last step is to transfer the file to the printer's storage over Wi-Fi/Ethernet cable, or by using a USB flash drive.



## First Use Preparations

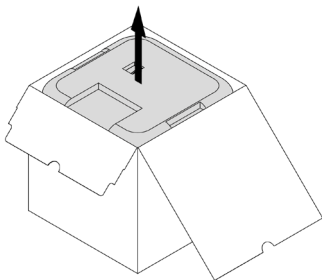

1. Open the box and remove the upper cushioning.

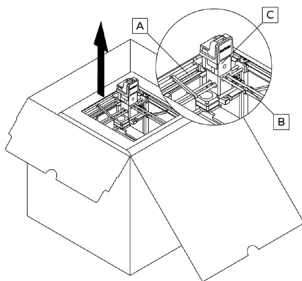

2. Take the 3D printer out of the box\*. When lifting or moving the printer, do not grab:

- A. belts
- B. shipping clips
- C. extruder

\*Due to the printer's weight, the Zortrax M300 Plus should be taken out of the box or moved by two people.

**zortrax**

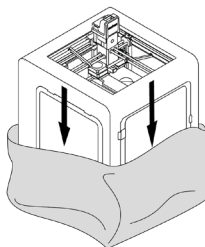

3. Remove the foil.

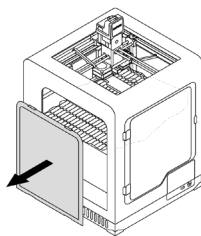

4. Remove one side cover - either left or right\*.

\*This step applies only to the M200 Plus.

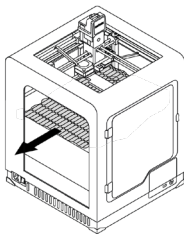

5. Remove the fillers.

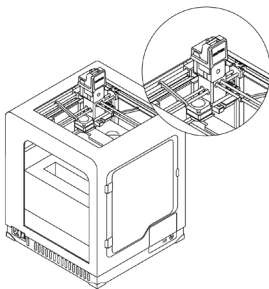

6. Remove the protection elements (shipping clips and safety belt).

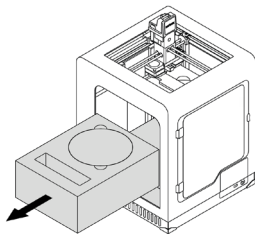

7. Remove the foam with accessories.

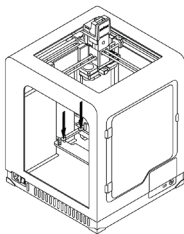

8. Lower the heatbed mount by pressing the places marked in the picture.

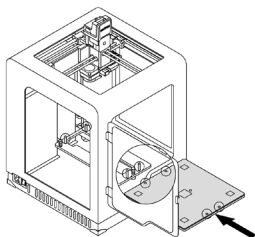

9. Install the build platform onto the bolts marked in the picture. Remember to install the platform with the perforated plate with its five silver calibration squares directed up.

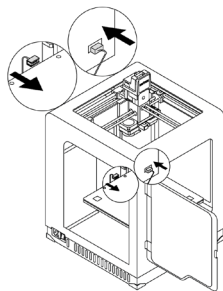

10. Plug the heatbed cable into the platform\* and into the adapter placed in the Z-axis cover.

\*For the M300 Plus, plug in the perforated plate small cable as well.

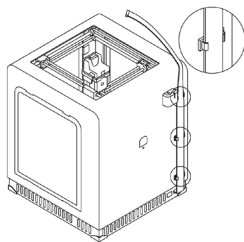

11. Install the extruder cable clamps in the holes at the back of the printer. Place the extruder cable in the clamps.

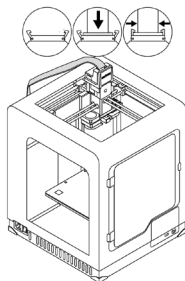

12. Remove the extruder top cover and plug in the extruder cable.

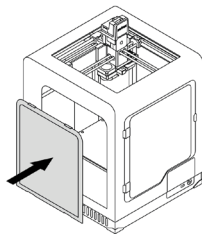

13. Install the side cover\*.

\*In the case of M300 Plus, install all side covers.

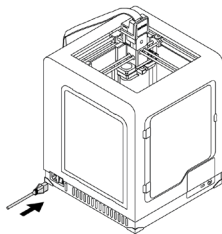

14. Plug in the power cable.

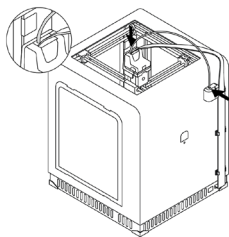

15. Attach the material guide to the extruder and to the material endstop.

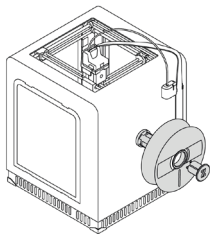

16. Attach the spool holder to the back of the printer. The holder can be opened with the push-to-open mechanism. Place the material spool onto the fixed part of the holder and press the other part until you hear a click.



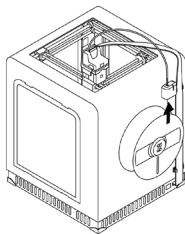

17. Feed the material into the extruder through the material endstop and the material guide.

🏠	TOOLS	
	MATERIAL	Z-ULTRAT >
🔧	PLATFORM	>
⚙️	HEAT EXTRUDER	🔥
🔄	RUN FAN TEST	🌀

🏠	TOOLS	
	HEAT PLATFORM	>
🔧	MOVE PLATFORM	⬆️
⚙️	CALIBRATE	🔍
🔄		

18. To calibrate the platform, select *Tools*, next *Platform*, and *Calibrate* from the menu. Follow the instructions displayed on the screen.

## Connecting the printer to a network



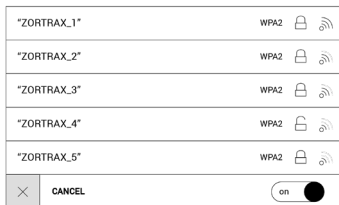
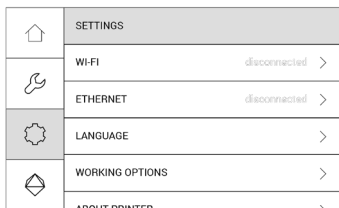

Each Zortrax M Series Plus printer can be connected to a local network in two ways: via Wi-Fi or an Ethernet cable. Both methods allow you to manage the printer directly from Z-SUITE and make it possible to remotely transfer .zcodex files from your computer to the printer.

To connect the printer to a Wi-Fi network, open the *Settings* menu and select *Wi-Fi*. From the list of available networks, choose your network and if it's required, enter the password. Select *Connect* to establish the connection.







SSID	"ZORTRAX_1"
FORGET	✕
IP ADDRESS	192.168.0.1
MANUAL IP	<input checked="" type="checkbox"/> off
IP ADDRESS	<input type="text"/>
✕	CANCEL
CONNECT	▶

To connect the printer with an Ethernet cable, create a local network and connect the router/modem/switch to the printer. The connection will be established automatically. You can control the Ethernet connection settings in the main menu; select *Settings* and *Ethernet*.

	SETTINGS
	WI-FI <span>disconnected &gt;</span>
	ETHERNET <span>IP: 192.168.0.1 &gt;</span>
	LANGUAGE <span>&gt;</span>
	WORKING OPTIONS <span>&gt;</span>
	ABOUT PRINTER <span>&gt;</span>

ETHERNET CARD	<input checked="" type="checkbox"/> on
IP ADDRESS	192.168.0.1
MAC ADDRESS	aa.bb.cc.dd.ee.ff
MODE	DHCP
IP ADDRESS	<input type="text"/>
✕	CANCEL
CONFIRM	✓

	SETTINGS
	WI-FI <span>disconnected &gt;</span>
	ETHERNET <span>disconnected &gt;</span>
	LANGUAGE <span>&gt;</span>
	WORKING OPTIONS <span>&gt;</span>
	ABOUT PRINTER <span>&gt;</span>

Once your printer is connected to the network, open the *My Devices* panel in Z-SUITE. You can search for devices available in the local network and add them to the program's panel. Select the icon with your printer's IP address and click on it to add the printer to the panel. You can also add a printer manually by typing its IP address.

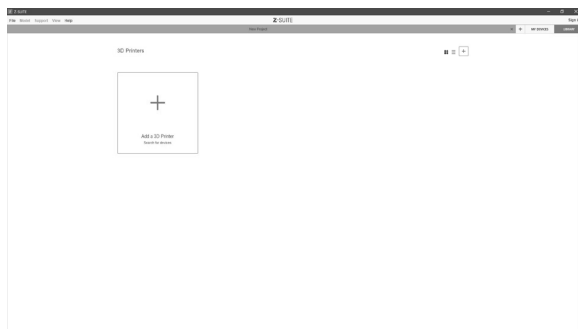

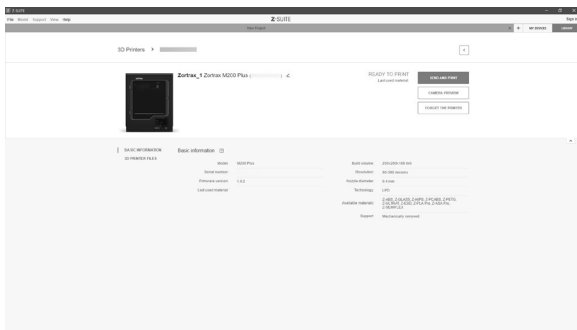
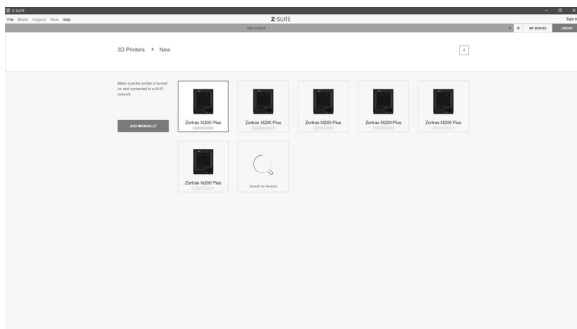

Each added printer can easily be managed in Z-SUITE. You can start, stop, and pause the printing process, see the printer's current state (*Ready to Print / Printing / Paused / Offline*), change the name of your printer, preview basic information about the printer, or display the preview from the printer's camera.

In the *3D Printer Files* tab, you can preview all .zcodex files that are stored on the printer's USB flash drive.

## Firmware Update

If your printer is connected to the Internet using either Wi-Fi or an Ethernet cable, it automatically checks for available firmware updates. Every time you turn on the printer, you will see the launcher displaying information about the current firmware version and whether the firmware can be updated. Once you get this notification, follow the instructions displayed on the screen.

You can go back to the launcher at any point of working with the printer and update the firmware. Open the *Settings* menu and select *Go to launcher*.

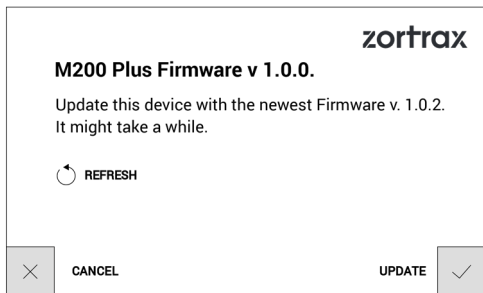

If you have decided not to connect the printer to the Internet, check <https://support.zortrax.com/downloads/> regularly for updates. To update the firmware, transfer the Update.zar file to a USB flash drive and plug it into the port at the front of the device. To start the installation, select *Refresh*.

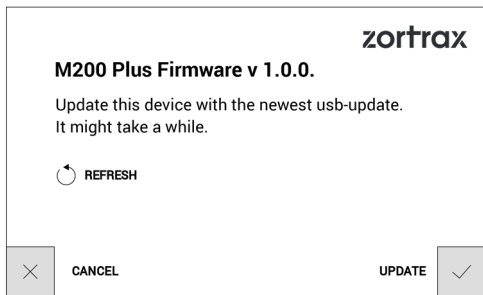

## Navigating through the Menu

The printer's functions can be activated or deactivated through the options available in the menu.

The main menu is divided into four submenus: HOME, TOOLS, SETTINGS and PRINT. Each category is discussed in detail below.

**HOME:** this menu displays all relevant information about the printer: the printer's IP address, the type of connection to a local network: either Wi-Fi or Ethernet cable, the material loaded into the extruder, and storage used on the USB flash drive.

**TOOLS:** this menu contains options that are useful during the printing process and maintenance work connected with the printer's main components:

### **MATERIAL**

Unload material – choose this option to change the material for a different color or type.

Load material – choose this option before starting the print or after changing the material.

### **PLATFORM**

Heat platform - this function heats up the platform to operating temperatures. It can be useful while performing platform maintenance work.

Move platform - this function allows you to change the position of the platform. Move up the platform if you want to access the bottom plate in order to clean it.

Calibrate - this function activates the procedure of platform calibration.

**HEAT EXTRUDER** - this function heats up the extruder to operating temperatures. It is very useful while replacing the nozzle and performing other extruder maintenance activities.

**RUN FAN TEST** - this function allows you to check the extruder fans for proper operation.

### **SETTINGS:**

Wi-Fi - this tab shows all available Internet networks and allows you to connect the printer to the chosen network.

Ethernet - this tab allows you to control the Ethernet connection settings.

Language - this tab allows you to change the language of the menu and printer messages.



Working options -> Model sorting - this function allows you to organize saved models by the date and time of saving, or by the file size.

Ignore material endstop - this option allows you to print without having to use the material endstop.

In this menu, you can also adjust the Screen brightness.

About printer - this tab contains information which identifies the printer model, its firmware and hardware version, serial number and total printing time.

**PRINT:** this tab includes all models saved on the USB flash drive. You can store all of your files in one or several folders. Here you can also select a model for printing.

## **Operating Modes of Zortrax M Series Plus Printers**

Zortrax printers indicate their current operating mode with the use of LED backlight. Every time the printer enters a given mode, the color of LED backlight changes into a different one.

### **Red backlight**

Red backlight indicates the heating mode, in which the printer is heating up the platform or the extruder.

### **White backlight**

White backlight indicates all other modes: printing, calibration, and standby.







## Material Loading







Open the *Tools* menu, and select *Material* and *Load material*. Next, select the material type you are going to use. At this point the printer will start to heat up the extruder.

**WARNING! The extruder will be hot. Don't touch it. Wear safety gloves.**

Once heating is completed, install the material spool on the spool holder at the back of the printer, feed the material into the extruder through the material endstop and the material guide.

Follow the instructions displayed on the screen.

	<b>TOOLS</b>	
	MATERIAL	>
	PLATFORM	>
	HEAT EXTRUDER	
	RUN FAN TEST	

	< TOOLS
	Unknown Material Type
	UNLOAD MATERIAL 
	LOAD MATERIAL 
	

	< MATERIAL
	Z-ABS
	Z-ULTRAT
	Z-HIPS
	Z-GLASS
	Z-PETG

**WARNING: The printhead is hot**

 **LOAD MATERIAL**

**Z-ULTRAT**

**Heating the extruder** **95%**

---

**CANCEL**

**WARNING: The printhead is hot**

 **LOAD MATERIAL**

**Z-ULTRAT**

**Material loading finished**







**DONE**







## Platform Calibration

Platform calibration involves a procedure of checking the distance between the nozzle and five points on the platform, and tightening/loosening the calibration screws.

Open the *Tools* menu, and select *Platform* and *Calibrate*. At this point the printer will begin to prepare for the calibration.

**WARNING!** The extruder will be hot during the calibration. Don't touch it. Wear safety gloves.

	TOOLS	
	MATERIAL	Z-ULTRAT >
	PLATFORM	>
	HEAT EXTRUDER	
	RUN FAN TEST	

	TOOLS	
	HEAT PLATFORM	>
	MOVE PLATFORM	
	CALIBRATE	
		

Once heating is completed, the printer will lift up the platform and display a message indicating that the three calibration screws placed under the platform need to be tightened. Once you've tightened the screws, select *Done* to continue.

The printer will start to check the distance between the nozzle and five silver points on the platform: two points at the front of the platform, two points at the back and the center point.

If the printer detects an incorrect distance in any of these points, the display will show instructions on what adjustments should be made. Follow the instructions and tighten or loosen the screw indicated in the message. Once you finish, select *Done* and the printer will recheck a given point on the platform.

If the distance between the nozzle and five points is set within the acceptable limits, the printer will finish the calibration procedure. Additionally, the display will show the calibration results. Select *Done* to finish the calibration.

## Z-SUITE Installation

The latest Z-SUITE update can be found in the *Downloads* section at: <https://support.zortrax.com>. To download and install Z-SUITE, you need to enter the serial number of your printer. The serial number can be found in the printer's menu: *Settings* -> *About Printer*, and on the nameplate at the back of the printer.

Remember to update Z-SUITE regularly. All updates are available at: <http://support.zortrax.com/downloads/>.

## Starting and Removing a Print

Once you have saved your model as a .zcodex file, you need to transfer it to the printer's storage. There are two ways to do it: you can either save the file on the USB flash drive and plug it into the port at the front of the printer, or you can transfer the file directly from Z-SUITE over Wi-Fi/Ethernet cable.

To start the printing process, open the *My Devices* tab in Z-SUITE and select the printer you want to work with. Next, open the *3D Printer Files* and from all models saved on the printer's storage, select the one you want to print and click the *Print* button.

You can also use the options from the main menu to print your model. Open the *Select Model* tab and from all models, select the one you want to print and tap *Print*.

At this point the printer will start to heat up the extruder.

**WARNING! The extruder will be hot. Don't touch it. Wear safety gloves.**

The printing process will start automatically.

Remove the print very carefully because there are some elements of the printer that can get damaged during the process. The following instructions show the correct procedure of removing the print from the platform.

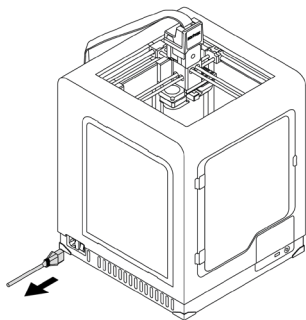

1. Turn off the printer and unplug the power cable.

**WARNING! WAIT 30 MINUTES UNTIL THE PLATFORM AND THE PRINT COOL DOWN.**

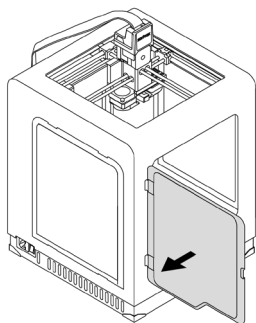

2. Open the front cover.



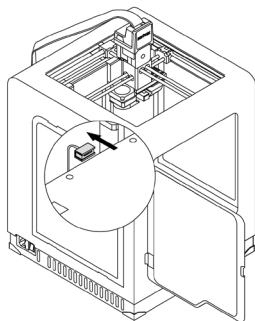

3. Unplug the heatbed cable from the platform.

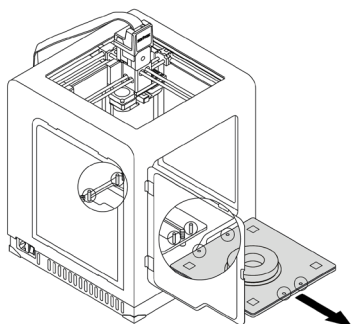

4. Remove the platform from the printer.

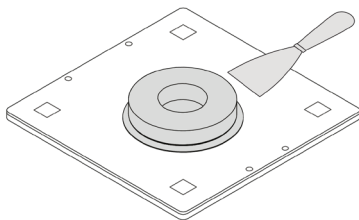

5. Use a spatula to remove the print.

**WARNING! REMOVE THE PRINT VERY CAREFULLY. WEAR SAFETY GLOVES.**

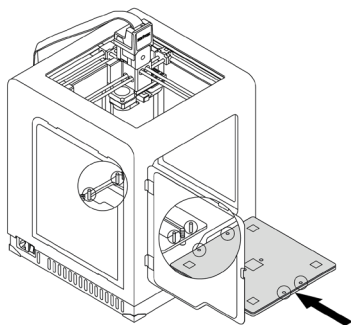

6. Put the platform back in the printer.

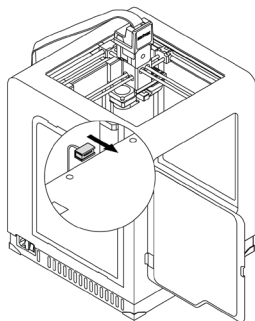

7. Plug in the heatbed cable.

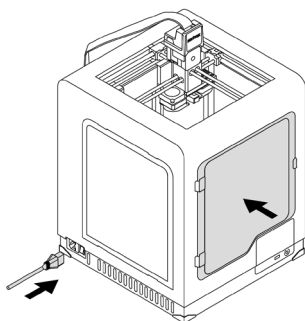

8. Close the front cover and plug in the power cable.

NOTE! ONCE THE PRINTING PROCESS IS FINISHED, UNLOAD THE MATERIAL AND TAKE THE SPOOL OFF OF THE SPOOL HOLDER, SECURE THE END OF THE MATERIAL AS IT IS SHOWN IN THE PICTURE TO AVOID HAVING TANGLED THREADS OF MATERIAL ON THE SPOOL.

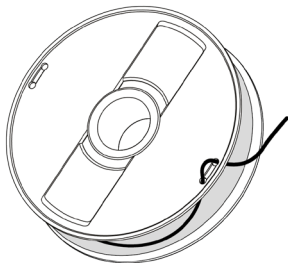

## Available Materials

The complete offer of materials is available at: <https://zortrax.com/materials/zortrax-m-series/>. Material *Technical Data Sheets* and *Safety Data Sheets* can be found at the same website.

When 3D printing with Zortrax devices, the Manufacturer recommends using Zortrax certified materials to acquire the best possible quality of the prints.

## Basic Maintenance and Service Work

Maintenance work should be regular in order to keep the printer in good condition and achieve high quality prints every time. Some parts require maintenance before each print and some every few hundred working hours. All maintenance activities do not take much time and are not complicated. Before commencing any repair, it is extremely important to turn off the printer and let it cool down. Remember to always wear safety gloves and glasses.

The printer is delivered with a full set of tools needed to carry out maintenance and service work.

The following tables present maintenance and repair guidelines connected with each section of Zortrax 3D printer, together with specific check points, necessary activities and their frequency.

## 1. Main

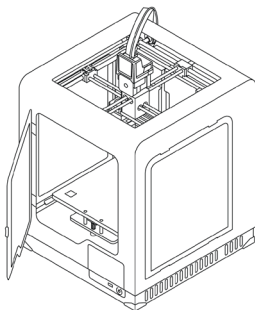

Activity	Frequency	Solutions to the problems	Necessary accessories
Cleaning the machine, its interior and surroundings, especially the bottom plate under the platform	Before each printing	The user is responsible for keeping the machine clean. To remove material remains from the interior of the device, use a vacuum cleaner or compressed air	- a vacuum cleaner, - cleaning products with a high evaporation rate
Cleaning the motherboard and the power supply unit from dust using compressed air	Every 300 working hours	Unscrew the bottom plate and use compressed air to remove dust	- a 2.5 Allen key - compressed air

ⓘ Lack of proper care of the machine can cause inadvertent damage or improper operation of the drive units

## 2. Hotend

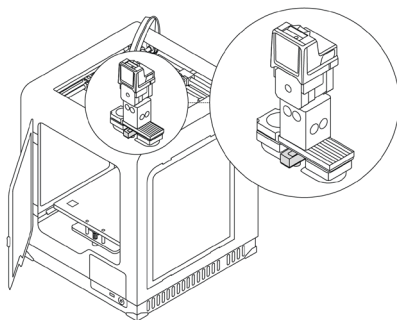

Activity	Frequency
Checking if the hotend and the nozzle are not clogged	Before each printing
Cleaning the nozzle	After finishing one spool of material
Checking if the screws that secure the heater and thermocouple are tightened	Every 300 working hours

① Lack of proper care of the machine can cause inadvertent damage or improper operation of the drive units

## 3. Platform

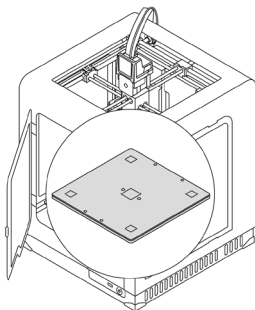

Activity	Frequency	Solutions to the problems	Necessary accessories
Cleaning the perforated plate	Before each printing	To remove material remains from the surface of the perforated plate, use a spatula	- a spatula
Checking the perforated plate for deformation	Before each printing	-	-
Calibration	Every 200 working hours	If the platform calibration fails, move on to the next step indicated in this table	-
Cleaning the heatbed and the underside of the perforated plate	Every 300 working hours	Unscrew the screws that secure the perforated plate and remove the residues from the underside of the plate using a spatula. The heatbed needs to be cleaned with a piece of cloth damped in acetone	- a spatula, - a piece of cloth, - acetone
Checking if the screws next to the platform's small connector are tightened (in the back left corner of the perforated plate)	Every 200 working hours	-	- a 2.5 Allen key

**ⓘ** Lack of proper care of the machine can cause inevent damage or improper operation of the drive units

## 4. X/Y axes; extruder guide rails

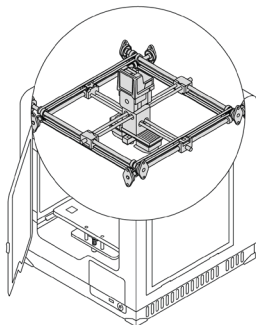

Activity	Frequency	Solutions to the problems	Necessary accessories
Checking if the axes and the extruder guide rails are clean from material remains and dust	Before each printing	It is possible to feel slight resistance while checking if the extruder moves freely on the guide rails. In such case you should check if the X/Y axes and the extruder guide rails are covered with black grime. The axes and guide rails should be cleaned with a cloth damped in acetone and then lubricated with grease supplied in the Starter Kit	-
Checking the tension of the drive belts on the X/Y axes	Every 300 working hours	In order to check the tension of the drive belts on the X/Y axes, move the extruder to the central point and gently tug the belts. If the belts are loosened, tighten the screws placed on the top part of the X/Y axes blocks	-
Checking the tension of the drive belts between the motors and the X/Y axes	Every 300 working hours	-	-
Checking if the screws on the X/Y axes and the motors pulleys are tightened	Every 300 working hours	-	-



Activity	Frequency	Solutions to the problems	Necessary accessories
Checking if the extruder moves freely when the printer is off	Every 300 working hours	-	-
Lubricating the X/Y axes and the extruder-guide rails	Every 200 working hours	-	- teflon grease

- ① Lack of proper maintenance of the X/Y axes can influence the final look of the print and cause the effect of shifted layers. Cleaning and lubricating the axes can help you save the material used for 3D printing as well as the time for preparing the device for printing

## 5. Extruder

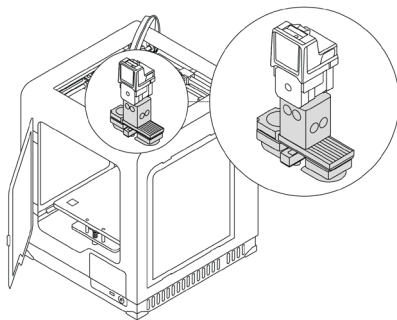

Activity	Frequency
Checking if the screws that secure the hotend are not loose and, if necessary, tightening them	Every 300 working hours
Removing the material remains and lumps from the extruder	Every 300 working hours
Checking if the fans are working	Every 300 working hours

- ① Lack of proper care of the machine can cause inevent damage or improper operation of the drive units

## 6. Z-axis

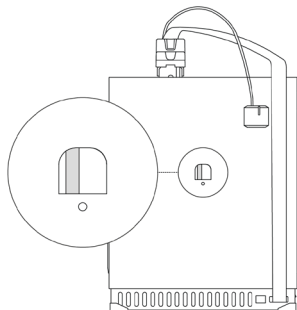

Activity	Frequency
Lubricating the Z-axis screw and rails	Every 400 working hours

- ① Lack of proper care of the machine can cause inevent damage or improper operation of the drive units

## Support and Troubleshooting

In order to ensure safety of every 3D printer's user, the Manufacturer provides various support while identifying and solving technical problems independently.

In case of difficulties with operating a Zortrax 3D printer, at first you should seek guidance in this User Guide, check the manuals available at: <http://support.zortrax.com/>, or consult our technical specialists through the Support Form available at: <http://support.zortrax.com/support-form/>.

The most common problems are listed below along with the list of possible solutions.

**The printer does not load the material into the extruder or the material is not extruded from the nozzle:**

1. Check if the material is not tangled on the spool or blocked near the inlet of the material endstop. If so, unload the material using options from the menu. Cut off the tangled or blocked fragment of the material. Reload the material and restart the printing process.
2. Check if the spool is properly secured on the spool holder. The spool may not be able to rotate if it has been installed incorrectly.
3. Make sure that the material is not faulty or irregular, that is, it does not have swells on its surface. If so, unload the material using options from the menu. Use a different spool.
4. Make sure that the end of the material loaded into the extruder has been cut at a right angle. Cut the end of the material at an acute angle to make material loading easier.
5. For further help, visit our Support Center at: <http://support.zortrax.com/>.

**The print cracks and does not adhere to the platform (it warps):**

1. If the print does not adhere to the platform:
  - carry out platform calibration again,
  - make sure that the side covers are installed,
  - make sure that the model is correctly designed and arranged in the workspace,
  - try adjusting the print settings differently by changing the level of infill and the model's arrangement in the workspace,
  - provide proper temperature in the printing room, before starting the printing process, make sure that the platform is sufficiently clean.

## 2. If the print cracks:

- make sure that the side covers are installed,
- make sure that the model is correctly designed and arranged in the workspace,
- try adjusting the print settings differently by changing the level of infill and the model's arrangement in the workspace,
- provide proper temperature in the printing room.

3. For further help, visit our Support Center at: <http://support.zortrax.com/>.

Whenever there is a technical issue caused by a hardware failure, negligence or inappropriate use of Zortrax printers, the firmware immediately displays an error message on the screen. The following list explains all error messages and provides potential causes and suggested solutions.



Error Message	Potential Cause	Suggested Solution
#100 Cannot establish communication	No connection between the touchscreen and the motherboard	-Restart the printer -Remove the bottom plate of the printer and check if all touchscreen cables are properly connected to the motherboard, and if the touchscreen PCB (LCD transfer) is properly connected to the motherboard -Contact your Reseller/Distributor
#101 Communication broken	No connection between the touchscreen and the motherboard	-Restart the printer -Remove the bottom plate of the printer and check if all touchscreen cables are properly connected to the motherboard, and if the touchscreen PCB (LCD transfer) is properly connected to the motherboard -Contact your Reseller/Distributor
#102 Update error	An error has occurred while installing the update	-Restart the printer -Remove the bottom plate of the printer and check if all touchscreen cables are properly connected to the motherboard, and if the touchscreen PCB (LCD transfer) is properly connected to the motherboard -Contact your Reseller/Distributor

## zortrax

#110 Unknown printer ID	The firmware is unable to read the printer's ID or it is incorrect.	- Turn off the printer and wait several minutes before restarting it. If the problem reoccurs, contact your Reseller/Distributor
#111 Unknown hardware ID	The firmware is unable to read the hardware's ID or it is incorrect.	- Turn off the printer and wait several minutes before restarting it. If the problem reoccurs, contact your Reseller/Distributor
#200 Small connector failure	No connection / short circuit between the perforated plate and the heatbed	-Check if the perforated plate is properly secured to the heatbed, and if the Pogo pins are not dirty or tarnished -Check if the heatbed cable is properly connected to the heatbed -Check if the heatbed cable is properly connected to the motherboard -Heatbed cable replacement -Heatbed cable adapter replacement
#201 Large connector failure	No connection / short circuit between the heatbed and the motherboard	-Check if the heatbed cable is properly connected to the heatbed -Check if the heated cable is properly connected to the motherboard -Heatbed cable replacement -Heatbed cable adapter replacement
#202 Extruder cable failure	No connection / short circuit between the extruder cable and the extruder	-Check if the extruder cable is properly connected -Extruder cable replacement -Extruder PCB replacement
#203 X/Y endstop failure	No signal coming from the X/Y axis endstop when the extruder reaches the "home" position (front left corner of the housing)	-Check if the X/Y axis endstops are properly connected -Carry out X/Y axes maintenance -X/Y axis endstop replacement
#204 Z endstop failure	No signal coming the Z-axis endstop when the platform is lowered to the very bottom	-Ensure that nothing is blocking the platform while it is moving to the very bottom -Check if the Z-axis endstop is properly connected -Z-axis endstop replacement

## zortrax

#205 Processor's power supply failure	There is a problem with the main power supply	<ul style="list-style-type: none"> <li>-Check if the power supply is sufficient</li> <li>-Replace the power cable</li> <li>-Contact your Reseller/Distributor</li> </ul>
#206 Temperature error	Too high extruder temperature or high extruder temperature changes	<ul style="list-style-type: none"> <li>-Check if the heater&amp;thermocouple are properly installed and secured in the hotend</li> <li>-Check if the extruder cable is properly connected</li> <li>-Heater&amp;thermocouple replacement</li> <li>-Extruder cable replacement</li> <li>-Extruder PCB replacement</li> </ul>
#207 Hotend heating failure	Too low extruder temperature	<ul style="list-style-type: none"> <li>-Check if the heater&amp;thermocouple are properly installed and secured in the hotend</li> <li>-Check if the extruder cable is properly connected</li> <li>-Heater&amp;thermocouple replacement</li> <li>-Extruder cable replacement</li> <li>-Extruder PCB replacement</li> </ul>

	<p>If the device begins to operate in an unidentified way, safely unplug the printer from the power supply and immediately contact the Support Center specialists via the support form at: <a href="http://support.zortrax.com/support-form/">http://support.zortrax.com/support-form/</a>.</p>
	<p>While shipping the device to the Manufacturer's technical service, it is extremely important to properly pack the printer. Use the original packaging. Detailed instructions on how to pack the device are available at:  M200 Plus - <a href="http://support.zortrax.com/m200-plus-packing/">http://support.zortrax.com/m200-plus-packing/</a>,  M300 Plus - <a href="http://support.zortrax.com/m300-plus-packing/">http://support.zortrax.com/m300-plus-packing/</a>.</p>

More manuals and tips & tricks articles are available at our Support Center.

[www.zortrax.com](http://www.zortrax.com)

## Specification

<b>Weight and Physical Dimensions</b>		
	<b>M200 Plus</b>	<b>M300 Plus</b>
Without a spool (W x D x H)	350 x 360 x 505 mm (13.8 x 14.2 x 19.9 in)	480 x 514 x 665 mm (18.9 x 20.2 x 26.2 in)
With a spool	350 x 430 x 505 mm (13.8 x 16.9 x 19.9 in)	480 x 576 x 665 mm (18.9 x 22.7 x 26.2 in)
Shipping Box	470 x 480 x 570 mm (18.5 x 18.9 x 22.4 in)	565 x 570 x 830 mm (22.2 x 22.4 x 32.7 in)
Device weight including the packaging	21 kg (46.3 lb)	41 kg (90.4 lb)
Shipping weight	23.5 kg (51.8 lb)	55 kg (121.3 lb)
<b>Printing</b>		
Technology	LPD (Layer Plastic Deposition) – depositing melted material layer by layer onto the build platform	
Layer resolution	90 - 400 microns	
Minimal wall thickness	400 microns	
Platform levelling	Automatic measurement of platform points' height	
<b>Device</b>		
Build volume	200 x 200 x 180 mm (7.9 x 7.9 x 7.1 in)	300 x 300 x 300 mm (11.8 x 11.8 x 11.8 in)
Material Container	Spool	

## zortrax

Material Diameter	1.75 mm (0.069 in)	
Nozzle diameter	0.3 mm, 0.4 mm (included), 0.6 mm (0.012 in, 0.016 in (included), 0.024 in)	
Support	Mechanically removed - printed with the same material as the model	
Extruder	Single (upgraded for more demanding materials)	
Extruder cooling system	Radial fan cooling the extruder block; two fans cooling the print	
Hotend	Redesigned (v3), new geometry of the nozzle	
Platform	Perforated, heated, equipped with Pogo pins	Perforated, heated pins
Material endstop	Mechanical	
Connectivity	Wi-Fi, Ethernet, USB	
Operating system	Android	
Processor	Quad Core	
Touchscreen	4" IPS 800 x 480	
Camera	Yes	
Available materials	Full offer is available at: <a href="https://zortrax.com/filaments/">https://zortrax.com/filaments/</a>	
External materials	Applicable	
<b>Temperature</b>		
Maximum printing temperature (extruder)	290° C (554° F)	



## zortrax

Maximum platform temperature	105° C (221° F)	
Ambient operation temperature	20 - 30° C (68 - 86° F)	
Storage temperature	0 - 35° C (32 - 95° F)	
<b>Electrical</b>		
	<b>M200 Plus</b>	<b>M300 Plus</b>
AC input	110 V ~ 5.9 A 50/60 Hz; 240 V ~ 2.5 A 50/60 Hz	
Maximum power consumption	320 W	360 W
<b>Software</b>		
Software bundle	Z-SUITE	
Supported input file types	.stl, .obj, .dxf, .3mf	
Supported operating systems	Mac OS X / Windows 7 and newer versions	
<b>Additional information</b>		
	<b>M200 Plus</b>	<b>M300 Plus</b>
	Each delivered printer may have worked up to 50 hours during the quality control test prints.	Each delivered printer may have worked up to 90 hours during the quality control test prints.

## Recycling

### Disposal of paper and plastic packaging

In order to protect the environment, the Manufacturer recommends placing used paper and plastic packaging in specially designated containers, according to your local recycling guidelines.

### Waste electrical and electronic equipment

This symbol placed on the device indicates that it is electrical and electronic equipment which must not be disposed of with household waste. Substances contained in the equipment may be harmful to the natural environment. Waste electrical and electronic equipment cannot be disposed of in landfills and must be recycled. For information on where to dispose of waste equipment, contact the seller, the Manufacturer or the importer of the product. Disposing of waste electrical and electronic equipment along with other waste is prohibited by the EU Directive 2012/19/UE.

## Certification



The Manufacturer ensures that the equipment complies with all relevant standards. In case of questions and problems, contact the Manufacturer through the support form: <http://support.zortrax.com/support-form/>.

# zortrax

With premium Reseller



office: [info@machines-3d.com](mailto:info@machines-3d.com)

technical support: [sav@machines-3d.com](mailto:sav@machines-3d.com)

more information: [Machines-3d.com](http://Machines-3d.com)

©2019 Zortrax S.A. All rights reserved.